

Catalog Number:	Project Name:	Note:	Date:	Type:
-----------------	---------------	-------	-------	-------

Portor's second generation AL2 Area Light Series is highly energy efficient and provides advanced optical control. The ultra slim profile delivers enhanced performance for general area lighting applications. The robust die-cast housing provides excellent thermal management for longer life and can withstand everyday harsh outdoor environments.

Ideal use for parking lots, car dealerships, walkways, school campuses, shopping centers and industrial areas



NOT FOR USE AS AN UP LIGHT

CONSTRUCTION

Die-cast aluminum body combined with state of the art heat dissipation. Waterproof, built rugged for outdoor harsh conditions.

ELECTRICAL

Built with the highest quality, long lasting Universal Voltage driver 120V-277V, 347V-480V optional, and water resistant LED chips.

OPTICAL SYSTEM

Comes standard with Type III optics designed to reduce glare and improve light distribution through precision formed lens optics. Type V is available.

MOUNTING

Multiple mounting options available: Slipfitter, square-pole mount, round-pole mount, u-bracket and trunnion mount.

SENSOR READY

Photocell sensor available.

DIMMING

1-10V dimmable

ENERGY SAVINGS

Over 70% energy savings than traditionally fluorescent fixtures, low heat productions requires less maintenance and operation cost.

LISTING

UL Listed, DLC Premium Listed, FCC, RoHS, CE, IP65 rated

WARRANTY

5 year Limited Warranty, Rated for 50,000 hours.

WATTAGE	DELIVERED LUMENS	EFFICACY
100W	14,241	144 lm/W
150W	21,593	145 lm/W
200W	29,757	149 lm/W
240W	35,511	147 lm/W
300W	44,324	148 lm/W
375W (Requires 2 drivers)	53,468	144 lm/w

TECHNICAL SPECIFICATION

CCT	3000K*, 4000K*, 5000K
CRI	70+
DIMMABLE	1-10V dimming
DISTRIBUTION	Type III, Type V
VOLTAGE	120V-277V, 347V-480V
SENSOR	Photocell capable
POWER FREQUENCY	50/60 Hz
POWER FACTOR	>0.9
THD	≤15%
WORKING TEMPERATURE	-40°F ~ 122°F
IP RATING	IP65 Wet Location
WARRANTY	5 year limited



ORDERING SAMPLE: PT-AL2-150W-50K

Series	Wattage	CCT	Voltage	Distribution	*Accessories/Options			
PT-AL2 Second Generation Area Light Series	100W	30K (3000K)*	LV (120V-277V) HV (347V-480V)	T3 (Type III) T5 (Type V)	Mounting (select one)	Photocell	Sensor	Shield
	150W*	40K (4000K)*						
	200W*	50K (5000K)			SF-AL2	PC	MS-UNI-MW	SHD-AL2-SM
	240W				SPM-AL2	PC-HV	RC-UNI-MW	SHD-AL2-LG
	300W*				SAM-AL2			
	375W	* (only for 150W, 200W, 300W)			TM-AL2			
					RPMA-AL2			

Catalog Number:	Project Name:	Note:	Date:	Type:
-----------------	---------------	-------	-------	-------

DIMENSION

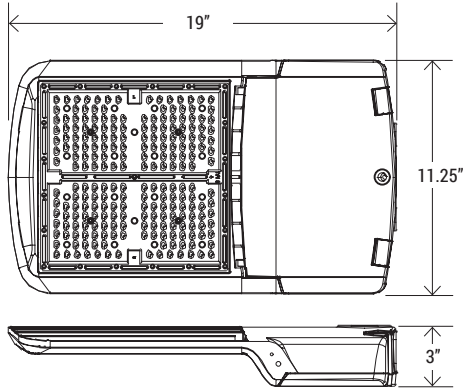

100W / 150W

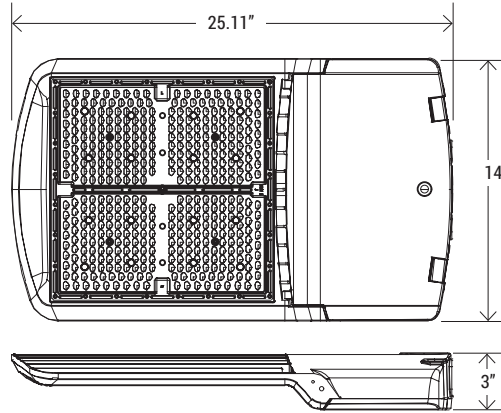

200W / 240W / 300W / 375W

SHIELD OPTION



SHD-AL2-SM
(100W/150W)
SHD-AL2-LG
(200W/240W/300W/35W)

Shield for AL Series

***MOUNTING OPTION (SOLD SEPARATELY)**



SF-AL2
Slipfitter



SPM-AL2
Adjustable Mount For
Square Pole



SAM-AL2
Straight Arm Mount for
Square Pole



TM-AL2
Trunnion Mount



UB-AL2
U-Bracket Mount

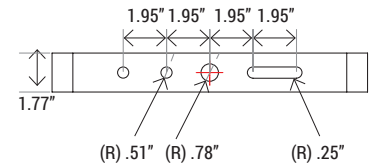
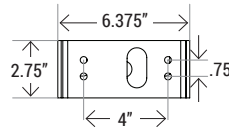
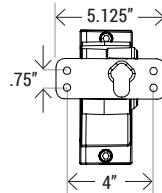
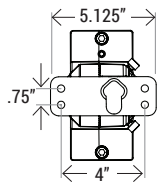
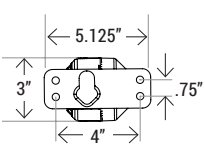
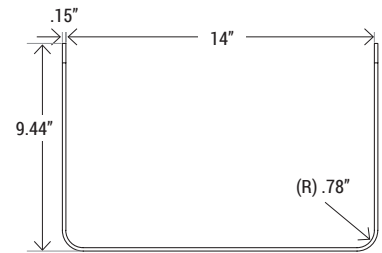
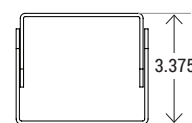
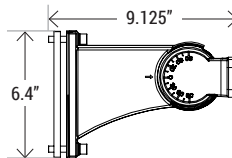
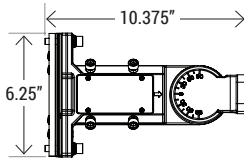
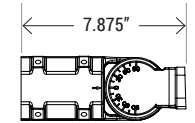

PHOTOCELL OPTION



PC
Photocell (120V-277V)



PC-HV
Photocell (480V)

SENSOR OPTION



MS-UNI-MW
Universal Microwave Motion Sensor



RC-UNI-MW
Remote Control

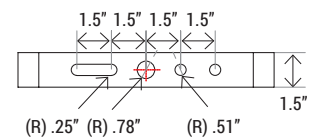
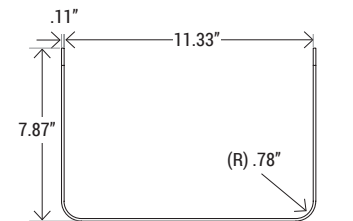

Catalog Number:	Project Name:	Note:	Date:	Type:
-----------------	---------------	-------	-------	-------

PT-AL2-100W-50K / PT-AL2-150W-50K

EPA	0.6 ft²
Net Weight	11.24 lbs / 11.9 lbs
Gross Weight	13.89 lbs / 14.55 lbs
Dimension	11.25" x 26.75" x 3"

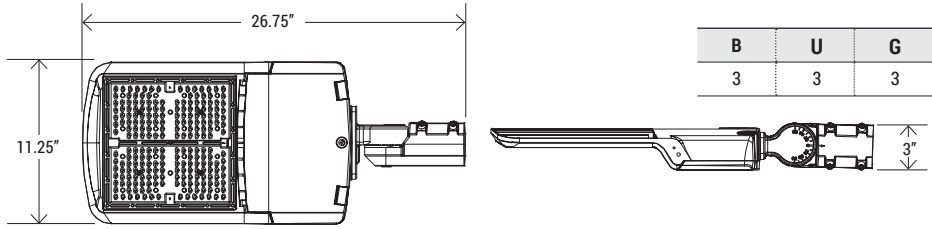

***WITH SLIPFITTER MOUNTING**

CONFIGURATION						
EPA	0.6 ft²	1.2 ft²	0.9 ft²	1.5 ft²	1.3 ft²	1.8 ft²
Net Weight	11.24 lbs / 11.9 lbs	22.48 lbs / 23.0 lbs	22.48 lbs / 23.0 lbs	33.72 lbs / 35.7 lbs	33.72 lbs / 35.7 lbs	44.96 lbs / 47.6 lbs

PT-AL2-200W-50K / PT-AL2-240W-50K

EPA	0.8 ft²
Net Weight	15.65 lbs / 15.87 lbs
Gross Weight	18.75 lbs / 18.96 lbs
Dimension	14" x 31.5" x 3"

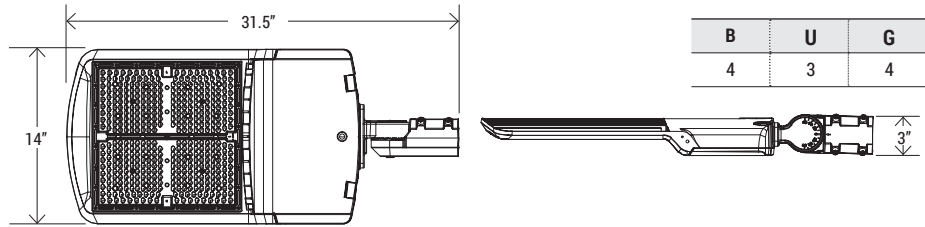

***WITH SLIPFITTER MOUNTING**

CONFIGURATION						
EPA	0.8 ft²	1.6 ft²	1.2 ft²	2.0 ft²	1.7 ft²	2.3 ft²
Net Weight	15.65 lbs / 15.87 lbs	31.3 lbs / 31.74 lbs	31.3 lbs / 31.74 lbs	46.95 lbs / 47.61 lbs	46.95 lbs / 47.61 lbs	62.6 lbs / 63.48 lbs

PT-AL2-300W-50K / PT-AL2-375W-50K

EPA	0.8 ft²
Net Weight	17.42 lbs
Gross Weight	20.72 lbs
Dimension	14" x 31.5" x 3"

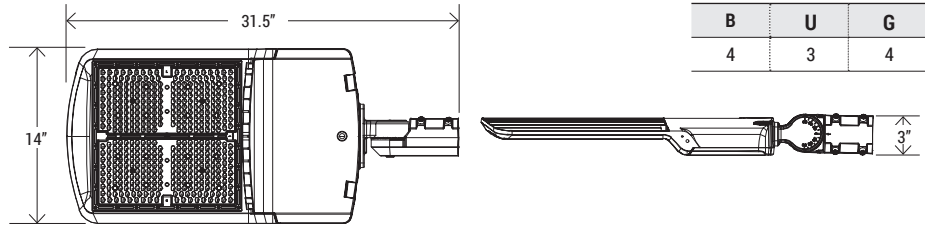

***WITH SLIPFITTER MOUNTING**

CONFIGURATION						
EPA	0.8 ft²	1.6 ft²	1.2 ft²	2.0 ft²	1.7 ft²	2.3 ft²
Net Weight	17.42 lbs	34.84 lbs	34.84 lbs	52.26 lbs	52.26 lbs	69.68 lbs

Catalog Number:	Project Name:	Note:	Date:	Type:
-----------------	---------------	-------	-------	-------

DISTRIBUTION

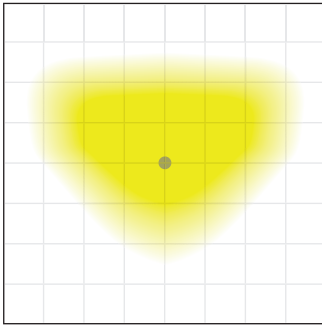

TYPE III
Type III distribution provides a wide, round pattern and yields an even light disbursement since the light projects outwards.

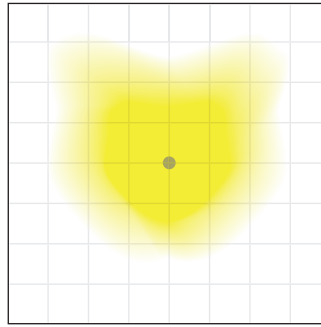

TYPE IV
Type IV has a preferred lateral width of 60° make it ideal for parking area and courtyard.

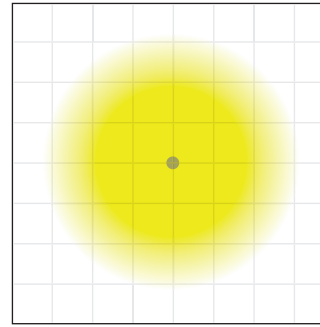

TYPE V
Type V provides central circular or square design pattern, equally across all angles from a central point.

ELECTRICAL LOAD

WATTAGE	120V	208V	240V	277V	347V	480V
100W	0.83 Amp	0.48 Amp	0.42 Amp	0.36 Amp	0.29 Amp	0.20 Amp
150W	1.25 Amp	0.72 Amp	0.63 Amp	0.54 Amp	0.43 Amp	0.31 Amp
200W	1.68 Amp	0.96 Amp	0.83 Amp	0.72 Amp	0.57 Amp	0.42 Amp
240W	2.0 Amp	1.15 Amp	1.00 Amp	0.87 Amp	0.69 Amp	0.50 Amp
300W	2.5 Amp	1.44 Amp	1.25 Amp	1.08 Amp	0.86 Amp	0.62 Amp
375W	3.1 Amp	1.8 Amp	1.56 Amp	1.35 Amp	1.08 Amp	0.78 Amp



DLC LISTING

CATALOG NUMBER	WATTAGE	DELIVERED LUMENS	EFFICACY	DLC PRODUCT ID	CLASSIFICATION
PT-AL2-100W-50K-LV-T3	100W	14,241	144 lm/W	PLXLWMOAUQ46	PREMIUM
PT-AL2-150W-50K-LV-T3	150W	21,593	145 lm/W	PLGQHIL80LLY	PREMIUM
PT-AL2-200W-50K-LV-T3	200W	29,757	149 lm/W	PL1TY14175W1	PREMIUM
PT-AL2-240W-50K-LV-T3	240W	35,511	147 lm/W	PLPSYYI3DYGM	PREMIUM
PT-AL2-300W-50K-LV-T3	300W	44,324	148 lm/W	PL77VVSYE17G	PREMIUM
PT-AL2-375W-50K-LV-T3	375W	53,468	144 lm/w	PL121T737FH3	PREMIUM
PT-AL2-375W-50K-HV-T3	375W	55,041	146 lm/w	PLE5ZK6ZF1UC	PREMIUM

Catalog Number:	Project Name:	Note:	Date:	Type:
-----------------	---------------	-------	-------	-------

PHOTOMETRICS (For complete IES file, please visit our website)

PT-AL2-100W	Wattage: 97.5W	Delivered lumens: 13,638	Efficacy: 140 lm/W	CCT: 5000K	CRI: 70
--------------------	-----------------------	---------------------------------	---------------------------	-------------------	----------------

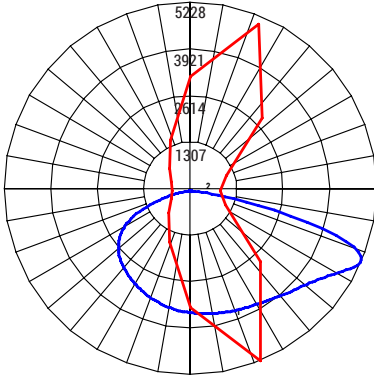

Maximum Candela : 5228.11 (Through Max. Cd.)
 — Vertical Plane Through Horizontal Angles (292.5-112.5)
 — Horizontal Cone Through Vertical Angle (68)

	0°	90°
0°	3470.220	3470.220
5°	3607.570	3483.330
15°	3800.130	3490.440
25°	3903.380	3472.470
35°	4015.310	3467.230
45°	4009.840	3485.720
55°	2872.560	3543.000
65°	1147.250	3535.290
75°	450.120	1498.450
85°	127.940	161.340
90°	20.160	5.620

	Lumens	%Lamp	%Fixture
Front-Low (0° - 30°)	1572.4	11.5	11.5
Front-Medium (30° - 60°)	4524.0	33.2	33.2
Front-High (60° - 80°)	2375.6	17.4	17.4
Front-Very-High (80° - 90°)	141.2	1.0	1.0
Back-Low (0° - 30°)	1282.5	9.4	9.4
Back-Medium (30° - 60°)	2574.7	18.9	18.9
Back-High (60° - 80°)	1019.5	7.5	7.5
Back-Very-High (90° - 90°)	48.7	0.4	0.4
Uplight-Low (90° - 100°)	16.4	0.1	0.1
Uplight-High (100° - 180°)	83.0	0.6	0.6
Total	13638.0	100.0	100.0

PT-AL2-150W	Wattage: 147.5W	Delivered lumens: 21,639	Efficacy: 147 lm/W	CCT: 5000K	CRI: 70
--------------------	------------------------	---------------------------------	---------------------------	-------------------	----------------

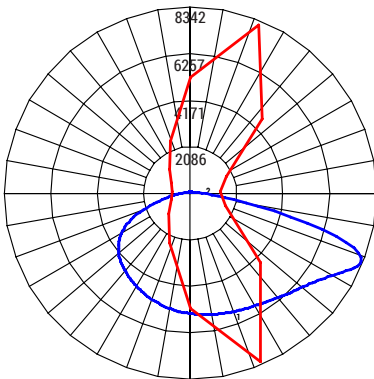

Maximum Candela : 8342.26 (Through Max. Cd.)
 — Vertical Plane Through Horizontal Angles (292.5-112.5)
 — Horizontal Cone Through Vertical Angle (68)

	0°	90°
0°	5544.440	5544.440
5°	5764.730	5557.050
15°	6081.980	5572.320
25°	6246.020	5537.720
35°	6400.990	5526.040
45°	6334.200	551.850
55°	4401.390	5621.620
65°	1756.750	5618.390
75°	691.340	2367.690
85°	174.000	254.380
90°	20.800	10540

	Lumens	%Lamp	%Fixture
Front-Low (0° - 30°)	2506.4	11.6	11.6
Front-Medium (30° - 60°)	7170.6	33.1	33.1
Front-High (60° - 80°)	3740.7	17.3	17.3
Front-Very-High (80° - 90°)	214.8	1.0	1.0
Back-Low (0° - 30°)	2053.0	9.5	9.5
Back-Medium (30° - 60°)	4135.9	19.1	19.1
Back-High (60° - 80°)	1649.2	7.6	7.6
Back-Very-High (90° - 90°)	75.4	0.3	0.3
Uplight-Low (90° - 100°)	13.8	0.1	0.1
Uplight-High (100° - 180°)	79.1	0.4	0.4
Total	21638.9	100	100

PT-AL2-200W	Wattage: 192.4W	Delivered lumens: 28,033	Efficacy: 146 lm/W	CCT: 5000K	CRI: 70
--------------------	------------------------	---------------------------------	---------------------------	-------------------	----------------

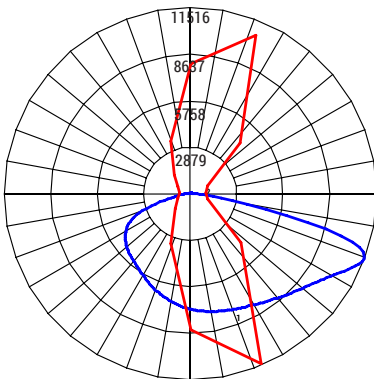

Maximum Candela : 11515.71 (Through Max. Cd.)
 — Vertical Plane Through Horizontal Angles (292.5-112.5)
 — Horizontal Cone Through Vertical Angle (70)

	0°	90°
0°	7284.250	7284.250
5°	7588.620	7280.020
15°	7994.930	7212.260
25°	8147.200	7116.720
35°	8354.970	7050.680
45°	8379.200	7162.170
55°	4916.920	7365.880
65°	1255.920	7687.900
75°	568.940	4507.580
85°	137.28	267.520
90°	20.910	23.010

	Lumens	%Lamp	%Fixture
Front-Low (0° - 30°)	3295.5	11.8	11.8
Front-Medium (30° - 60°)	9309.3	33.2	33.2
Front-High (60° - 80°)	4714.6	16.8	16.8
Front-Very-High (80° - 90°)	215.2	0.8	0.8
Back-Low (0° - 30°)	2617.9	9.3	9.3
Back-Medium (30° - 60°)	5296.3	18.9	18.9
Back-High (60° - 80°)	2343.3	8.4	8.4
Back-Very-High (90° - 90°)	97.8	0.3	0.3
Uplight-Low (90° - 100°)	23.0	0.1	0.1
Uplight-High (100° - 180°)	120.5	0.4	0.4
Total	28033.4	100	100

Catalog Number:	Project Name:	Note:	Date:	Type:
-----------------	---------------	-------	-------	-------

PHOTOMETRICS (For complete IES file, please visit our website)

PT-AL2-240W	Wattage: 231.2W	Delivered lumens: 34,277	Efficacy: 148 lm/W	CCT: 5000K	CRI: 70
--------------------	------------------------	---------------------------------	---------------------------	-------------------	----------------

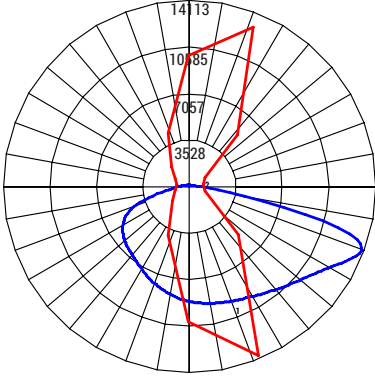

Maximum Candela : 14113.43 (Through Max. Cd.)
 — Vertical Plane Through Horizontal Angles (292.5-112.5)
 — Horizontal Cone Through Vertical Angle (69)

	0°	90°
0°	8920.400	8920.400
5°	9337.520	8920.190
15°	9940.900	8817.630
25°	10170.960	8690.630
35°	10357.620	8561.250
45°	10378.320	8645.360
55°	6623.750	8889.990
65°	1545.570	9488.310
75°	719.830	7307.660
85°	218.700	363.400
90°	28.000	33.440

	Lumens	%Lamp	%Fixture
Front-Low (0° - 30°)	4078.8	11.9	11.9
Front-Medium (30° - 60°)	11559.2	33.7	33.7
Front-High (60° - 80°)	5841.0	17.0	17.0
Front-Very-High (80° - 90°)	290.5	0.8	0.8
Back-Low (0° - 30°)	3151.6	9.2	9.2
Back-Medium (30° - 60°)	6293.0	18.4	18.4
Back-High (60° - 80°)	2777.3	8.1	8.1
Back-Very-High (90° - 90°)	105.8	0.3	0.3
Uplight-Low (90° - 100°)	29.1	0.1	0.1
Uplight-High (100° - 180°)	150.7	0.3	0.3
Total	34277.0	99.9	100

PT-AL2-300W	Wattage: 290.2W	Delivered lumens: 41,945	Efficacy: 145 lm/W	CCT: 5000K	CRI: 70
--------------------	------------------------	---------------------------------	---------------------------	-------------------	----------------

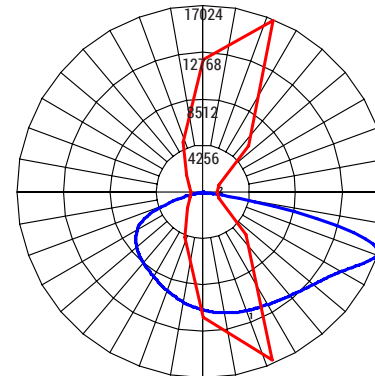

Maximum Candela : 17023.77 (Through Max. Cd.)
 — Vertical Plane Through Horizontal Angles (67.5-247.5)
 — Horizontal Cone Through Vertical Angle (70)

	0°	90°
0°	10905.470	10905.470
5°	11366.810	10942.390
15°	11974.220	10893.940
25°	12177.970	10818.560
35°	12442.080	10864.710
45°	12581.640	8725.140
55°	7691.530	8101.030
65°	1921.050	6681.630
75°	863.840	2596.520
85°	210.670	355.910
90°	20.760	27.820

	Lumens	%Lamp	%Fixture
Front-Low (0° - 30°)	4923.2	11.7	11.7
Front-Medium (30° - 60°)	13884.4	33.1	33.1
Front-High (60° - 80°)	7196.0	17.2	17.2
Front-Very-High (80° - 90°)	331.8	0.8	0.8
Back-Low (0° - 30°)	3922.1	9.4	9.4
Back-Medium (30° - 60°)	7909.2	18.9	18.9
Back-High (60° - 80°)	3479.5	8.3	8.3
Back-Very-High (90° - 90°)	140.2	0.3	0.3
Uplight-Low (90° - 100°)	25.0	0.1	0.1
Uplight-High (100° - 180°)	133.7	0.3	0.3
Total	41945.1	100	100