

Catalog Number:	Project Name:	Note:	Date:	Type:
-----------------	---------------	-------	-------	-------

The RHB High Output Round High Bay fixture is efficient, durable and designed to withstand harsh conditions with its remarkable heat dissipation, dust-tight body and resistance to water. RHB is wattage and color selector, and can be programmed with a CCT of 3500K, 4000K or 5000K, eliminating the need to stock multiple color temperatures.

Premium quality provides excellent solution for high-ceiling mount applications, especially in warehouse, storage, gymnasiums, retail spaces and convention centers.

11" / 13"
..... DIAMETER



CONSTRUCTION

Die-cast aluminum heat sink provides superior thermal transfer to extend lifespan of the luminaire. Built rugged to withstand harsh conditions, IP65 rated. Fixture comes standard with J-hook for suspended mounting.

ELECTRICAL

Luminaire is built with the highest quality driver that is Universal Voltage (120-277V), uses long lasting, high-efficient LED packages.

LENS

Clear PC lens.

SENSOR READY

Motion sensor ready (optional).

ENERGY SAVINGS

Over 50% energy savings than traditionally metal halide fixtures, low heat productions requires less maintenance and operation cost.

LISTING

UL Listed, DLC Premium Listed, RoHS, IP65 rated

WARRANTY

5 year Limited Warranty

WATTAGE	DELIVERED LUMENS	EFFICACY
100W/120W/150W	22,314	153 lm/W
180W/200W/240W	37,943	162 lm/W

Based on highest wattage setting @ 4000K. Actual lumens may vary.

TECHNICAL SPECIFICATION

CCT	3500K/4000K/5000K
CRI	80
DIMMABLE	0-10V dimmable
BEAM ANGLE	90°
VOLTAGE	120V - 277V, 50/60 Hz
POWER FACTOR	>0.9
THD	≤20%
WORKING TEMPERATURE	-40°F ~ 122°F
STORAGE TEMPERATURE	-40°F ~ 176°F
DRIVER SURGE PROTECTION	6KV
IP RATING	IP65 Wet Location
FINISH COLOR	Black, White
WARRANTY	5 year limited



ORDERING SAMPLE:

_____ - _____ - _____ - _____ - _____ - _____ - _____ - _____ - _____ - _____

Series	Size	CCT/Wattage	Voltage	Color	Accessories/Options (Sold separately)				
PT-RHB Round High Bay with CCT and Wattage Selector	11D (11" dia.)	3CP (35K/40K/50K) (100W/120W/150W)	Blank (120-277V)	BK (Black) W (White)	Mounting	EM Battery	Sensor	Reflector/Bottom Cover	Wire guard
	13D (13" dia.)	3CP (35K/40K/50K) (180W/200W/240W)			Blank (Standard J-hook) UB-RHB-SM	Blank (No option) PT-EMU3-25W	Blank (No option) MS-UNI-PR MSH-RC2	Blank (No option) RFL-PC-RHB-SM RFL-AL-RHB-SM RFL-PC-BC-RHB-SM	Blank (No option) WG-RHB-SM
					UB-RHB-LG	PT-EMU3-40W		RFL-PC-RHB-LG RFL-AL-RHB-LG RFL-PC-BC-RHB-LG	WG-RHB-LG

Catalog Number:	Project Name:	Note:	Date:	Type:
-----------------	---------------	-------	-------	-------

DIMENSION

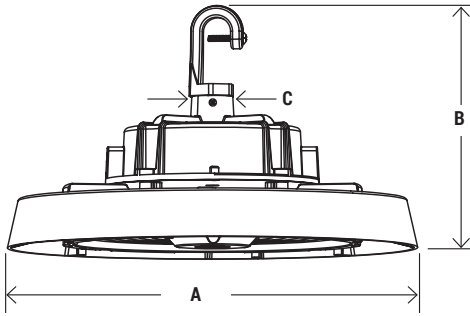

MODEL#	A	B	C (THREAD SIZE)
PT-RHB-11D-3CP	11"	6.4"	.5"
PT-RHB-13D-3CP	13.4"	6.5"	

QTY/BOX



MOUNTING OPTION



UB-RHB-SM
U-Bracket Mounting
for RHB-11D



UB-RHB-LG
U-Bracket Mounting
for RHB-13D

WIRE GUARD OPTION

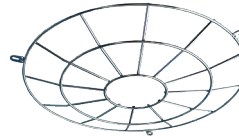

WG-RHB-SM
Wire guard for RHB-11D

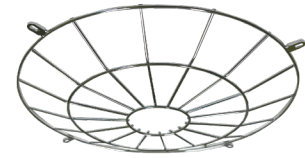

WG-RHB-LG
Wire guard for RHB-13D

REFLECTOR/BOTTOM COVER OPTION

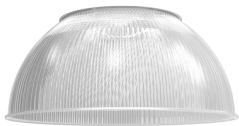

RFL-PC-RHB-SM (11D)
RFL-PC-RHB-LG (13D)
PC Reflector for RHB



RFL-PC-BC-RHB
PC Reflector Bottom Cover for RHB
(Must use with reflector)



RFL-AL-RHB-SM (11D)
RFL-AL-RHB-LG (13D)
Aluminum Reflector for RHB

EM BATTERY OPTION



PT-EMU3-25W (11D)
PT-EMU3-40W (13D)
Emergency LED Driver For
Round High Bay

SENSOR OPTION

(Remote control required, no factory
installation required)





PT-UNI2-SP-PR
Universal Short Pin
PIR Motion Sensor



MSH-RC2
Remote Control

Catalog Number:	Project Name:	Note:	Date:	Type:
-----------------	---------------	-------	-------	-------

CATALOG NUMBER	WATTAGE	DELIVERED LUMENS	EFFICACY	DLC Pproduct ID
PT-RHB-11D-3CP	100W	14668 @ 3500K	147 lm/W	 S-5E8TWJ
		15848 @ 4000K	164 lm/W	
		15039 @ 5000K	151 lm/W	
	120W	16726 @ 3500K	140 lm/W	
		18484 @ 4000K	160 lm/W	
		17510 @ 5000K	146 lm/W	
	150W	20005 @ 3500K	132 lm/W	
		22314 @ 4000K	153 lm/W	
		21236 @ 5000K	139 lm/W	

CATALOG NUMBER	WATTAGE	DELIVERED LUMENS	EFFICACY	DLC Pproduct ID
PT-RHB-13D-3CP	180W	25233 @ 3500K	140 lm/W	 S-ZQTR5
		28218 @ 4000K	163 lm/W	
		26669 @ 5000K	148 lm/W	
	200W	28137 @ 3500K	140 lm/W	
		31094 @ 4000K	161 lm/W	
		29318 @ 5000K	147 lm/W	
	240W	33477 @ 3500K	134 lm/W	
		37943 @ 4000K	162 lm/W	
		33840 @ 5000K	139 lm/W	

PHOTOMETRICS DATA (For complete IES files, please go to our website: www.portorlighting.com)

PT-RHB-11D-3CP	Wattage: 150W	Delivered lumens: 22314	Efficacy: 153 lm/W	CCT: 4000K	CRI: 80
-----------------------	----------------------	--------------------------------	---------------------------	-------------------	----------------

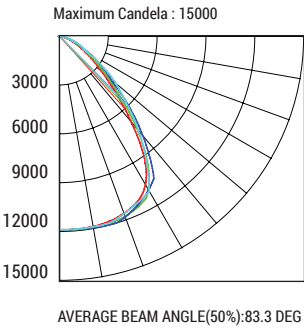

RcR	Coefficients of Utilization												
	pfc		80%				70%				50%		
	pcc	pw	70%	50%	30%	10%	70%	50%	30%	10%	50%	30%	10%
0	119	119	119	119	116	116	116	116	111	111	111		
1	111	108	104	101	109	105	102	100	101	99	97		
2	103	97	91	87	101	95	90	86	92	88	84		
3	96	87	81	75	94	86	80	75	83	78	74		
4	89	79	72	66	87	78	71	66	76	70	65		
5	83	72	64	59	81	71	64	58	69	63	58		
6	77	66	58	52	76	65	58	52	63	57	52		
7	72	60	53	47	71	60	52	47	58	52	47		
8	68	56	48	43	66	55	48	43	54	47	42		
9	63	51	44	39	62	51	44	39	50	43	39		
10	60	48	40	36	58	47	40	36	46	40	35		

CP Summary		
	0°	90°
0°	10519.0	10519.0
5°	10514.0	10515.0
15°	10502.0	10549.0
25°	9516.2	10269.0
35°	7535.7	8556.0
45°	4454.6	4940.8
55°	2433.6	2343.4
65°	1018.1	954.03
75°	314.55	340.22
85°	116.22	5.086
90°	17.063	2.591

Zonal Lumen Summary		
	Lumens	%Fixture
0° - 20°	3965.49	19.00
0° - 30°	8513.16	40.90
0° - 40°	13486.68	64.70
0° - 60°	13360.51	92.90
0° - 80°	20747.88	99.60
0° - 90°	20838.08	100.00

PT-RHB-13D-3CP	Wattage: 240W	Delivered lumens: 37943	Efficacy: 162 lm/W	CCT: 4000K	CRI: 80
-----------------------	----------------------	--------------------------------	---------------------------	-------------------	----------------

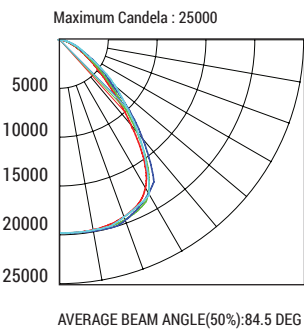

RcR	Coefficients of Utilization												
	pfc		80%				70%				50%		
	pcc	pw	70%	50%	30%	10%	70%	50%	30%	10%	50%	30%	10%
0	119	119	119	119	116	116	116	116	111	111	111		
1	111	108	104	101	109	106	103	100	101	99	97		
2	104	97	92	87	101	95	90	86	92	88	84		
3	96	88	81	76	94	86	80	75	83	78	74		
4	89	79	72	67	87	78	71	66	76	70	65		
5	83	72	65	59	81	71	64	59	69	63	58		
6	77	66	58	52	76	65	58	52	63	57	52		
7	72	61	53	48	71	60	53	47	58	52	47		
8	68	56	48	43	66	55	48	43	54	47	43		
9	64	52	44	39	62	51	44	39	50	44	39		
10	60	48	41	36	59	47	41	36	46	40	36		

CP Summary		
	0°	90°
0°	17175.930	17175.930
5°	17160.471	17157.811
15°	17129.570	17153.900
25°	15623.490	16939.900
35°	12429.370	14417.660
45°	7535.230	7902.330
55°	3943.690	3542.280
65°	1611.170	1497.360
75°	537.670	544.300
85°	188.940	49.560
90°	14.580	8.040

Zonal Lumen Summary		
	Lumens	%Fixture
0° - 20°	6466.83	19.10
0° - 30°	13939.47	41.30
0° - 40°	22163.1	65.60
0° - 60°	31462.75	93.10
0° - 80°	33635.07	99.50
0° - 90°	33788.06	100.00